

TRUEBOND DUET









Operator's Manual



TABLE OF CONTENTS

- Symbols.....1
- Caution Warning Statements2
- Model Description4
 - Features4
 - Intended Use4
 - Warranty.....4
- Initial Setup.....5
- Quick Start6
- Settings7
- Operation.....7
- Error indicators7
- Balancing Loads8
- Rotor Removal And Installation.....8
 - To install the rotor8
 - To remove the rotor8
- O-Ring replacement and installation9
- Care and Preventative Maintenance9
- Cleaning and Disinfection10
- Calibration Testing.....10
- Troubleshooting11
- General Specifications12
- Replacement Parts.....13

SYMBOLS

Symbol	Definition	Use
	Caution	Caution to safety hazard. Potential risk of personal injury or damage to the instrument if improperly handled. Consult the manual before proceeding.
	Manufacturer	Manufacturer of record.
	Electrical and electronic products recycling symbol	Recycle only as electronic waste. Do not dispose in normal waste.
	RoHS Compliant	Compliance with RoHS environmental standards.
	CE Mark	Denotes conformity to specific European directives and regulations.
	UK Mark	Denotes conformity to specific UK directives and regulations.
	MET Listing	Denotes conformity to specific safety standards and regulations.
FDA LISTED	FDA Listed	Denotes that the product has been properly listed with the FDA.
	ISO Certification	Denotes conformity to quality standards and quality management systems.

CAUTION WARNING STATEMENTS



This device is intended to be operated by properly trained personnel who have carefully read the operating manual and are familiar with the function of the device. Users should also comply with the specimen receptacle manufacturer's specific instructions for use, in addition to any other protocols established by the testing organization.



WARNING: For the safety of both the operator and service personnel, care should be taken when using this centrifuge if handling substances that are known to be toxic, radioactive or contaminated with pathogenic microorganisms. Use appropriate personal protection equipment (PPE). When Risk Group II materials are used, (as identified in the World Health Organization "Laboratory Bio-Safety Manual"), a Bio- Seal should be employed. In the event that materials of a higher risk group are being used, more than one level of protection must be provided. The use of flammable or explosive materials as well as those materials which have a vigorous chemical reaction is prohibited.



Unplug the centrifuge before cleaning or performing maintenance.



WARNING: Inspect centrifuge for cracks or physical damage to cabinet, lid, rotor, or o-ring. Damage may result in unsafe operation. Discontinue use until repairs have been performed.



The use of flammable or explosive materials as well as those materials which have a vigorous chemical reaction is prohibited.



For your safety and durability of the machine, never transport or store centrifuge with tube holders inside the machine.



WARNING: "Universal precautions"¹ should be followed in handling all items contaminated with blood or other bodily fluids.



This equipment generates, uses, and can radiate radio frequency energy, and if not installed and used in accordance with this operator manual, may cause interference to radio communications.



Operation of this equipment in a residential area may cause interference, in which case the user will be required to correct the interference at his own expense.



Operation of this equipment in a manner not specified by the manufacturer may impair the protection provided by the equipment.



Electrical Safety protection is provided by properly connecting the centrifuge to earth ground. Use only the manufacturer provided line cord and ensure that it is connected to a properly grounded power receptacle. Failure to do so will result in an electrical hazard.



WARNING: Do not make modifications to or remove any hardware from rotor without prior authorization from Drucker Diagnostics.



WARNING: Only use Drucker Diagnostics components in this centrifuge.



Due to the lack of the possibility of human exposure, all Drucker centrifuges and accessories sold by Drucker Diagnostics, Inc. are compliant without any special labeling required by the California Safe Drinking Water and Toxic Enforcement Act (Proposition 65).



Do not leave any rotor on the rotor-holder when the centrifuge is not in use for an extended period of time. Doing so may compress the O-Ring and decrease its ability to hold rotors.



If rotor is left in position between runs, be certain to completely seat the bottom of the rotor on the holder before spinning another sample. Failure to correctly seat the rotor each time can cause the rotor to become loose during centrifugation.



Never operate the centrifuge without the rotor properly mounted. Failure to install and secure the rotor correctly can damage the centrifuge.

1 Recommendations for Prevention of HIV Transmission in Health Care Settings. MMWR 1987; 36 (Supplement #2S)

MODEL DESCRIPTION

TrueBond Duet is a versatile centrifuge designed with 5 settings to process Serum, Urine, and Microhematocrit specimens in the same unit. Minimize lab error, reduce turnaround time, and streamline training with the simple controls, powerful performance.

This general-purpose laboratory centrifuge may also be used to spin approved containers with biologics, chemicals (non-flammable, non-explosive, non-volatile, and non-highly reactive), and environmental samples.

FEATURES

- The five (5) cycles are conveniently pre-set and labeled for your lab's most common applications.
- A traditional audible alert indicates the completion of the cycle.
- Cool-Flow design prevents overheating of samples by using ambient air to keep specimens at room temperature.
- A lid permits safe observation of samples and optical calibration of speed.
- The lid safety system prevents the centrifuge from operating unless the lid is closed and latched.
- The lid safety system only allows entry into the centrifuge after the rotor has completely stopped.
- The high-power brushless motor provides years of operation with no routine maintenance.

INTENDED USE

Vet Use Only. General purpose laboratory centrifuge, intended for the density-based separation of fluids through centripetal acceleration.

WARRANTY

Drucker Diagnostics warranties that this centrifuge is free from defects in workmanship and parts for 2 years.

INITIAL SETUP

- Unpack and verify that all the following are included:
 - Centrifuge
 - Power cord
 - Power Supply
 - Tube rotor
 - Microhematocrit Rotor
 - Microhematocrit Reader Card
 - Quick Start Guide
 - Latch Release Tool

- Setup the centrifuge on flat and level surface. A bench top clearance height of 21" (54 cm) is required to open the lid.
- The centrifuge should have 6" (15 cm) of clear space around the centrifuge. Proper ventilation is necessary to prevent the overheating of samples as well as premature failure of the centrifuge. Choose an area which allows unencumbered air flow, and where the temperature remains between 16°C and 32°C.
- No hazardous material shall be permitted in the clearance envelope during operation.
- The operator time within the envelope shall be limited to the time necessary for loading, unloading, and centrifuge operation only.
- Plug the line cord into the centrifuge.
- Plug the line cord into an approved electrical outlet.
- Open the lid.



BE SURE THE ELECTRICAL OUTLET IS ALWAYS ACCESSIBLE AS THE LINE CORD IS THE MEANS OF EMERGENCY DISCONNECTION!

QUICK START

The screen display alternates between the name of the currently selected cycle and its parameters. For convenience, the first three (3) cycles are preset for common applications:

- | | |
|------------|---------------------------------|
| (1) Quick | STAT Centrifugation at 12,000xg |
| (2) Normal | STAT Centrifugation at 12,000xg |
| (3) Long | STAT Centrifugation at 12,000xg |
| (4) Urine | STAT Centrifugation at 3,900xg |
| (5) MHCT | STAT Centrifugation at 13,700xg |

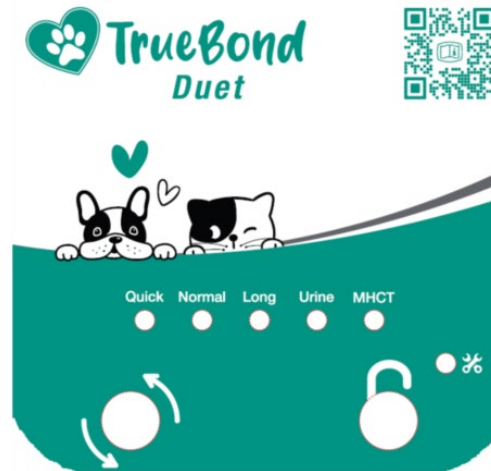

	Start	Begins running the cycle displayed on the screen. The lid must be closed.
	Unlock	Allows access into the rotor chamber by engaging the unlocking mechanism. Entry is only possible when the rotor is stopped.
	Stop	Pressing the UNLOCK button during operation will terminate the run. Once the rotor has come to a stop, pressing the UNLOCK button again will open the centrifuge.
	Error / Service Light	The red indicator with an adjacent wrench symbol flashes to signal an error condition or remains continuously illuminated when service is needed.

	Cycle Selection	The LED light above the numbers indicates the cycle currently selected. To change the selected cycle, open the lid and press the UNLOCK button in succession until the desired cycle is selected. Two seconds after selection, the button reverts to its UNLOCK function.
	Lock Cycle Selection	Open lid. Select desired cycle. Press and hold the UNLOCK button for 5 seconds. Three beeps will confirm that cycle selection is locked.
	Unlock Cycle Selection	To re-enable cycle selection, open lid, then press and hold the UNLOCK button for 5 seconds. Three beeps will confirm that cycle selection is now unlocked.

SETTINGS

	(1) Quick	(2) Normal	(3) Long	(4) Urine	(5) MHCT
RPM	15,800	15,800	15,800	9,800	18,800
Time	30 secs	1.5 mins	2.5 mins	45 secs	2 min
G-Force	12,000	12,000	12,000	3,900	13,700

OPERATION

- Install the rotor, be sure to follow the instructions for installing the Rotor on page 8.
- Place the tubes into the Inserts. Be sure to follow the rules for balanced loads as listed on page 8.
CAUTION: Do not use glass tubes of any kind in the Fixed-angle Microtube Rotor.
- The front panel LED is illuminated for the currently selected cycle. The selected cycle determines the run time and speed. To select another cycle, press the UNLOCK button in succession until the desired cycle is selected. Note: cycle selection is only available with the lid open.
- Close the lid by pressing lightly down on the front edge of the lid. An audible “click will indicate the lid is fully closed.
- Pushing the START button on the control panel will start the spin cycle.
- When the cycle is completed, the rotor will slow to a complete stop.
- The lock will disengage, and the lid will automatically open.
- You may now safely remove your samples.

ERROR INDICATORS

The combination of the Error / Service Indicator and the cycle LEDs on the front panel specify the error code.

Error / Service Indicator

- When the Quick Cycle LED and Error/Service Indicator Flash, it indicates the centrifuge rotor failed to reach full speed in 30 seconds
- When the Normal cycle LED and Error/Service Indicator flash, it indicates cover opened or cycle changed during operation.
- When the Long cycle LED and Error/Service Indicator flash, it indicates the centrifuge unable to maintain rotor speed

BALANCING LOADS



Your centrifuge must contain a balanced load to work properly. Spinning balanced loads will extend the life of the centrifuge and produce better results. Use the following rules when loading the rotor. If an odd number of samples is to be spun, fill a tube with water to match the weight of the unpaired sample and place it across from this sample.



Fixed-Angle MicroTube Rotor must be balanced.

Opposing tube slots must be equally loaded or empty or loaded with equally weighted samples.

ROTOR REMOVAL AND INSTALLATION

TO INSTALL THE ROTOR

1. Place the rotor back onto the O-Ring Adapter Assembly. Press firmly in a downward motion on the rotor-holder.
2. If the rotor becomes difficult to install, apply a very small amount of silicon-type lubricant to the 3 points on the O-Ring Gasket.
3. As the rotor turns, the O-Ring moves outward by centrifugal force, enhancing the frictional coupling between the rotor-holder and the rotor.
4. It is recommended that the initial setup procedures be performed to ensure that the rotor has been installed correctly and that no damage has been done to the centrifuge during either the rotor installation or possible rotor chamber cleaning. See page 5 for this procedure.

TO REMOVE THE ROTOR

1. Unlock the centrifuge by pushing the 'OPEN / STOP' button and unlatch and open the lid.
CAUTION: Unplug the centrifuge from the electrical outlet to eliminate the possibility of electrical shock or other injury.
2. The rotor is sitting on the O-Ring adapter. Pull the rotor up and off of this adapter.



Do not leave any rotor on the rotor-holder when the centrifuge is not in use for an extended period of time. Doing so may compress the O-Ring and decrease its ability to hold rotors.



If rotor is left in position between runs, be certain to completely seat the bottom of the rotor on the holder before spinning another sample. Failure to correctly seat the rotor each time can cause the rotor to become loose during centrifugation.

O-RING REPLACEMENT AND INSTALLATION

The figure illustrates the position of the rubber O-Ring which is attached to the rotor-holder. If the rotor becomes difficult to install, apply a very small amount of silicone-type lubricant to the 3 points on the O-Ring gasket. The O-ring should be inspected regularly and replaced when it appears “flattened” or worn. The O-Ring should be replaced as preventative maintenance at least once a year.

A new O-Ring can be installed as shown, by weaving it behind and in front of the 6 pins on the rotor-holder.

The Points at which the O-Ring touches the rotor are indicated by the number 1 in the figure below.

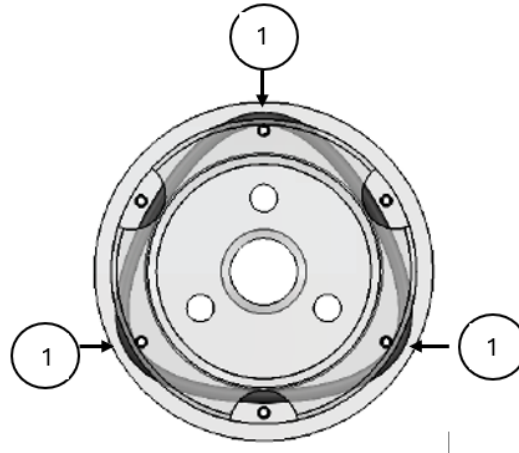

CARE AND PREVENTATIVE MAINTENANCE

With proper care and maintenance, your centrifuge will provide years of laboratory service. For proper care, the following steps should be taken:

- **Always Spin Balanced Loads:** Make certain that you are always spinning a balanced load, as shown in the previous section. These centrifuges have a unique counter balanced motor mounting design which produces excellent vibration dampening. However, out-of-balance loads may break test tubes and may produce unsatisfactory separation results. Proper load balancing will improve sample separation and extend the life of the centrifuge.
- **Motor and Electrical Maintenance:** The highest quality electrical components have been selected for the centrifuges and should not need maintenance or servicing for the life of the centrifuge.
- **Rotor:** It is recommended that the rotors be inspected regularly for cracks and visible wearing. If cracks and visible wear are discovered, replace immediately.
- **Microhematocrit Rotor Cushions:** It is recommended that the rubber cushions provided with the rotor be replaced twice a year or whenever a tube breaks in the rotor.
- **O-Ring:** It is recommended that the O-Ring be inspected regularly and replaced when it appears flattened or worn. The O-Ring should be replaced at least once a year.
- **Remove Accessories Before Moving:** All samples and rotors must be removed from the rotor chamber before transporting or storing the centrifuge to prevent damage and injury.

CLEANING AND DISINFECTION

To prolong the life of the centrifuge, cleaning and disinfection is recommended every six months or whenever there is a spillage or tube breakage. Contaminants must be removed immediately, or corrosion and premature degradation of components can occur. Before using any cleaning or decontamination methods other than those recommended by the manufacturer, users should verify with the manufacturer that the proposed method will not damage the equipment.



Cleaning and Decontamination may be necessary as a safeguard before laboratory centrifuges, rotors, and any accessories are maintained, repaired, or transferred.

- Unplug the centrifuge before cleaning.
- Use appropriate personal protective equipment (PPE).
- Apply Cleaning solutions with a dampened towel or cloth ONLY. Do not spray or pour cleaning solution directly onto or into the centrifuge. Do not saturate or submerge the centrifuge in water or other cleaning solutions as this will cause damage, create a safety risk, and void the warranty.
- ONLY isopropyl alcohol or a 10% (5500 PPM) bleach solution should be used to disinfect the centrifuge and its accessories.
- All surfaces must be dried immediately after cleaning and disinfecting.



TBQ GERMICIDAL PRODUCTS ARE NOT RECOMMENDED AS THEY MAY CAUSE DAMAGE TO THE CENTRIFUGE. WIPE OFF THOROUGHLY AFTER USE TO PREVENT VOIDING THE WARRANTY.

- Fully/partially halogenated hydrocarbons, ketones, esters, ethers, benzyls, ethyl benzenes, and all other chemicals not prescribed by the manufacturer shall not be used as they may cause damage to the rotor chamber, rotor, tube holders, accessories and centrifuge exterior and void the warranty.

CALIBRATION TESTING

It is recommended that the top speed be tested every two years for continued safe operation. Contact Customer Service for further information or testing availability.

TROUBLESHOOTING

NOTE: The latch must be turned completely clockwise to its stop position for the centrifuge to operate.

<p>If The centrifuge does not run</p>	<ul style="list-style-type: none"> ○ Verify that the centrifuge is powered. One of the LED lights should be on. ○ Ensure the lid is closed and latched. Audible alarm consisting of two long beeps will alert you that the Lid is not closed when pressing the START button. To close the lid, press lightly on the front edge of the lid. An audible “click” will indicate the lid is fully closed. ○ If the centrifuge still does not run, contact Customer Service.
<p>The rotor does not spin freely</p>	<ul style="list-style-type: none"> ○ Make sure nothing has fallen into the rotor chamber, following the procedure above. ○ If nothing obstructs the rotor, the rotor may be damaged. Contact Customer Service for further assistance.
<p>The centrifuge makes a rattling noise when running</p>	<ul style="list-style-type: none"> ○ Stop the centrifuge. Open the lid. ○ Wearing PPE, remove tubes and look for fallen objects or debris. Carefully reach inside the rotor chamber with a tool to remove them. ○ Inspect the rotor for damage. ○ If the rotor appears damaged, contact Customer Service for further assistance.
<p>Excessive noise or vibration when the centrifuge is running</p>	<ul style="list-style-type: none"> ○ Verify that all four centrifuge feet are properly seated on a flat surface. ○ Ensure that the load is balanced according to instructions in the “Balancing Loads” section of this manual. ○ Make sure that nothing has fallen into the rotor chamber.
<p>The centrifuge stops and 4 short beeps repeat continuously</p>	<p>The load is not balanced. Press the UNLOCK button, open the lid, and balance the load as recommended elsewhere in this manual.</p> <p>Confirm that all tubes are properly loaded into the centrifuge rotor.</p>
<p>The centrifuge does not unlock after a run is completed</p>	<ul style="list-style-type: none"> ○ Wait until the rotor has come to a complete stop. If the lid does not open, press the UNLOCK button and try again. ○ If no LED light is on, the unit is not powered, and the lid will not unlock by conventional means. Insert the provided tool through the hole located on the side of the centrifuge front panel. Press in through this hole and into the cabinet to engage the emergency unlock. Once the emergency unlock is engaged, the lid will pop open. ○ If the unit is damaged, contact Customer Service for assistance.
<p>The lid does not open</p>	<ul style="list-style-type: none"> ○ Press the UNLOCK button to open lid. ○ If the lid remains locked after completing emergency unlock, the electronics may have been damaged. Contact Customer Service for assistance.
<p>Clicking noise during braking gets loud</p>	<ul style="list-style-type: none"> ○ Make sure that the screw in the center of the rotor is tight.

GENERAL SPECIFICATIONS

The rotor and accessories are rated for the maximum rotation frequency shown in the table below.

Tube Capacity	2 – 1.5mL & 2.0mL tubes 12 – 40mm Microhematocrit tubes
Dimensions (H x W x D)	6.87 in x 7 in x 7 in (17 cm x 18 cm x 18 cm)
Weight	4.3 lbs. (1.95 kg)
Sound Level	59 dB A
Centrifuge Motor	Brushless DC
Max g-Force*	12,000 xg / 13,700 xg
Max Speed	15,800 RPM (+/- 100)
Cycle Time	30 seconds, 1.5 minutes, 2.5 minutes, 45 seconds, & 2 mins (+/- 2%)
Acceleration Time	Approximately 6 seconds
Deceleration Time	Approximatley 10 seconds
Incoming to Power Supply	
Supply Voltage	100 – 240 (+/- 10%)
Supply Frequency	50 - 60 Hz
Current Consumption	1.3 – 0.6A
Incoming to Centrifuge	
Voltage	24VDC
Current Consumption	3.75A
Environmental Conditions	
Set-up Site	Indoor, dry Use Only
Altitude	Up to 2,000m from Sea Level
Ambient Temperature	5 °C to 40 °C
Humidity	Maximum relative humidity 80% for temperatures up to 31 °C, decreasing linearly to 50% relative humidity at 40 °C
Overvoltage Category	II
Pollution Degree	2

*The rotor and accessories are rated for the maximum rotation frequency shown.

Maximum sample density is 1.15 grams/mL, (water density = 1.0 grams/mL)

REPLACEMENT PARTS

02-001-0-0029	Fixed Angle Microtube Rotor
02-001-0-0030	Microhematocrit Rotor
30-000250	O-Ring
02-006-0-0061	PC Board
02-006-0-0060	Interface PC Board
03-1-0005-0306	Motor Assembly
02-002-1-0152	Lid Assembly
02-002-1-0138	Seal, lid gasket
03-1-0005-0320	Power Cord
03-1-0005-0316	Power Supply
03-0-0003-0913	Front Panel Label
03-0-0003-0926	Lid Label
03-0-0003-0922	Read Operator's Manual Label
30-000215	Foot, Rubber
00-100-100-009	6 Series Soft Button Replacement Kit
02-001-0-0031	Microhematocrit Lid Assembly
03-1-0012-0232	Microhematocrit Circular Reader Card
30-000212K	Latch Release Tool

Use only approved accessories from the original manufacturer. A complete list of accessories is available at www.druckerdiagnostics.com.

This operator's manual is part number 03-0-0002-0322 Rev. A

Product Family: DASH Series (DASH Micro, Apex 4, TrueBond Duet)

Complies with UL61010-1/CSA C22.2 No. 61010-1 and IEC61010-2-020

Protected by U.S. Patents #6,811,531, # 7,422,554, #D718,463, & #D734,489. Other Patents Pending

FOR VETERINARY USE ONLY



INSTRUCTIONS FOR DISPOSAL OF WEEE BY USERS IN THE EUROPEAN UNION



This product must not be disposed of with other waste. Instead, it is the user's responsibility to dispose of their waste equipment by handing it over to a designated collection point for the recycling of waste electrical and electronic equipment. The separate collection and recycling of your waste equipment at the time of disposal will help to conserve natural resources and ensure that it is recycled in a manner that protects human health and the environment. For more information about where you can drop off your waste equipment for recycling, please contact your local city office, waste disposal service, or where you purchased the product.

Designed, built, and supported in the USA.



 **Drucker Diagnostics**

200 SHADY LANE, SUITE 170 – PHILIPSBURG, PA 16866, USA

+1-866-265-1486 (U.S. ONLY) - +1-814-692-7661

CUSTOMERSERVICE@DRUCKERDIAGNOSTICS.COM

DRUCKERDIAGNOSTICS.COM

