

horizon

MODEL 755VES



Model 755VES Operator's Manual

Laboratory Centrifuge



► **Table of Contents**



Model Description	3
Supplied Equipment	3
Warranty Information	3
Specifications	4
Control Panel / Parts of the Centrifuge	5
Setup Location	6
Initial Setup Procedure	6-7
Operation	7
Tube Holder Configurations	
<i>Horizontal Rotor</i>	8
<i>6-Place 50 mL Fixed-Angle Rotor</i>	9
Control Panel Functions	
<i>Time Adjustment and Timer Operation</i>	10
<i>Speed Adjustment / RCF Display</i>	10
<i>Starting and Stopping a Run</i>	10
<i>Unlocking the Lid</i>	10
Advanced User Settings	
<i>Acceleration Rate</i>	10
<i>Braking Rate</i>	11
<i>Countdown Delay</i>	11
<i>Imbalance Detection</i>	11
<i>Audible Setting</i>	11
Memory Locations / Storing and Recalling	12
Mechanical Cycle Counter	12
Care and Preventative Maintenance	13
Troubleshooting	14
Safety	15
Emergency Rotor Chamber Entry	15
Calibration and Earth Ground Testing	15
Replacement Parts	16

WARNING

For the safety of both the operator and service personnel, care should be taken when using this centrifuge if handling substances that are known to be toxic, radioactive or contaminated with pathogenic microorganisms. When Risk Group II materials are used (as identified in the World Health Organization “Laboratory Bio-Safety Manual”), a Bio-Seal should be employed. In the event that materials of a higher risk group are being used, more than one level of protection must be provided. The use of flammable or explosive materials as well as those materials which have a vigorous chemical reaction is prohibited.

Model Description

The Horizon Model 755VES, Premier, features the largest holding capacity of Drucker’s Performance Series centrifuges. Its standard horizontal rotor and carriers can accommodate up to 24 test tubes. The 755VES offers control over almost every aspect of the unit’s operation from variable acceleration and deceleration to easy time and speed input. High speed and force capability produces platelet-poor/free plasma and greatly reduces processing times. The exclusive Drucker horizontal rotor allows for quick and easy sample loading and complete horizontal separation. Save settings in one of 10 memory locations and recall them at the touch of a button.



Intended Use

This is a general purpose laboratory centrifuge intended for safe and rapid density based separation of fluids, including physiologic fluids, in approved specimen receptacles, for qualitative or quantitative test procedures. This device is intended to be operated by properly trained personnel who have carefully read and understood the Operating Manual.

Users should also comply with the specimen receptable manufacturer’s specific instructions for use, in addition to any other protocols established by the testing organization.

Supplied Accessories (Standard)

See next page for optional rotor/accessories

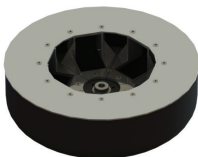

One (1) 6-Carrier
Horizontal Rotor*
p/n 7786015



Six (6) 4-Place Carriers*
p/n 7713023



Six (6) Carrier Cap*
p/n 7713035

*The rotor and rotor accessories are rated for a rotational speed of 3800 RPM (a force of 2560 xg).

Also included (not shown):

- One (1) 10’ Line Cord
- One (1) Operator’s Manual
- Twenty-Four (24) 0.25” Cushions for Glass Tubes

See the next page for a description of optional accessories.

WARRANTY:

Drucker Diagnostics warrants that this centrifuge is free from defects in workmanship and parts for 2 years.

Specifications

General Specifications for the Horizon Model 755VES Centrifuge

Overall Dimensions (H x W x D): 10.5" x 14.5" x 17"
Centrifuge Motor: 1/2 H.P. Brushless DC
Protection Breaker: 4 Amp. re-settable
Timer: Electronic, with hold or 0 to 99 minutes, +/- 1%
Weight: 39 lbs.

Permitted Environmental Conditions

Ambient Temperature During Operation: 2 °C - 35 °C
Maximum Relative Air Humidity: 90%

Electrical Requirements

Power (Watts): 200
Voltage (Volts): *standard:* 115 (+/- 10)*
optional: 100 (+/- 10)*; 230 (+/- 20)*
Frequency (Hz): 50/60

*See label on rear of centrifuge for voltage requirements.

	PART NO.	#	MAX TUBE SIZE	SPEED RANGE	FORCE RANGE	
	6-Carrier Horizontal Rotor (Standard)	7786015	<i>Comes with your choice of 6 of the holders listed</i>			
	w/4-Place Carrier	7713023	24	17 mm x 100 mm	500 to 4,300 RPM	40 to 3,150 xg
	w/4-Place Carrier	7713023	12	17 mm x 125 mm	500 to 4,300 RPM	40 to 3,150 xg
	w/50 mL Hor. Carrier	7713037	6	34 mm x 115 mm	500 to 4,300 RPM	40 to 3,150 xg
	6-Place 50 mL Fixed-angle Rotor	7786044	<i>Comes with 6 of the holders listed</i>			
	50 mL Fixed-angle	7787051	6	34 mm x 125 mm	500 to 3,200 RPM	40 to 2,000 xg
	Microplate Rotor	7786051	2	96 Well Microplate	500 to 1,500 RPM	35 to 320 xg

Contact your authorized dealer or Drucker Diagnostics to order accessories.



4-Place Carrier
p/n 7713023



50 mL Carrier
p/n 7713037



Carrier Cap
p/n 7713035

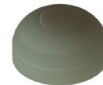

0.25" Tube Cushion
p/n 9150



50 mL Tube Holder
fixed-angle p/n
7787051



.5 to 1 mL
Tube Adapter
p/n 7713068



1.5 to 2 mL
Tube Adapter
p/n 7713065



13 x 75 mm Insert
p/n 7713064



13 x 100 mm Insert
p/n 7713066

Control Panel / Parts of the Centrifuge

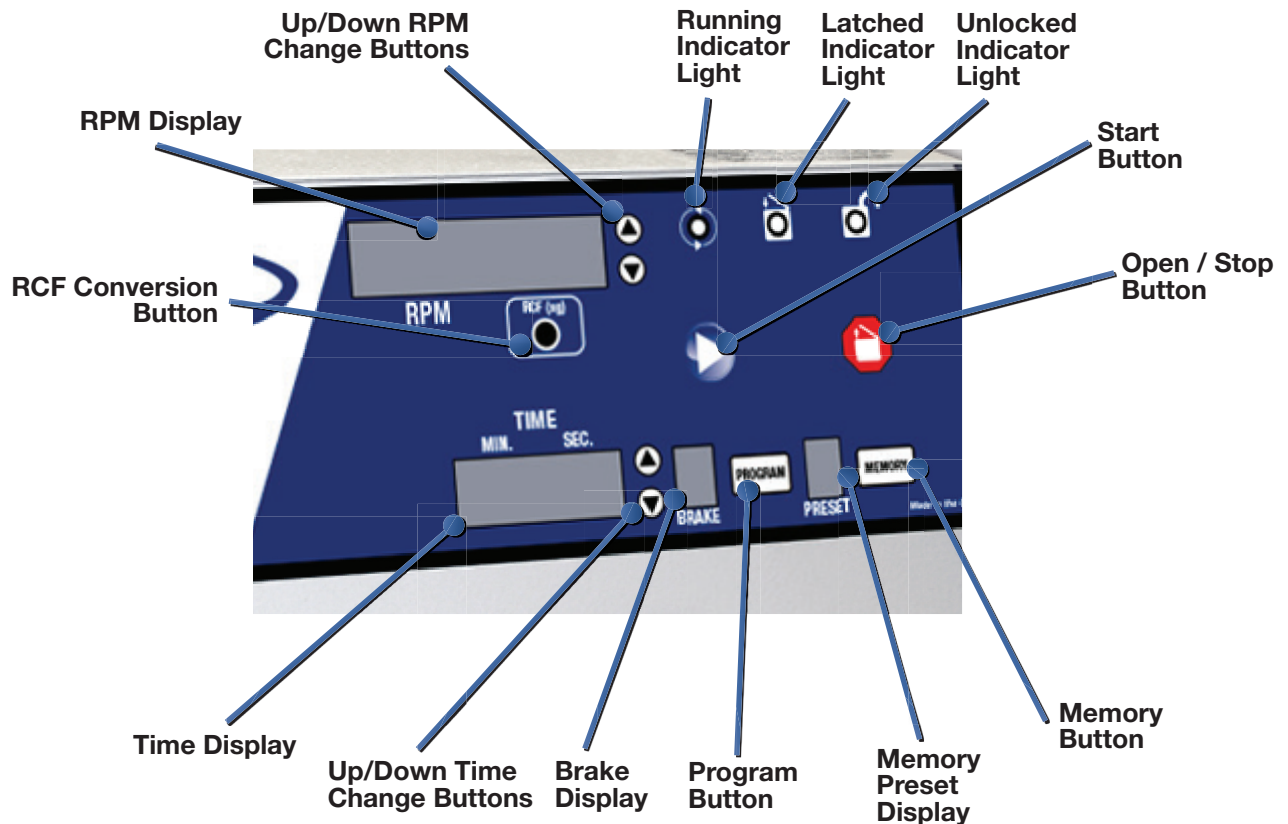

Setup Location

1. Unpack the centrifuge and verify that all of the supplied equipment is present.
2. Choose a setup location which meets the following criteria:
 - a) A bench top clearance height of 20" is required in order to open the lid.
 - b) The clearance envelope is the space around the centrifuge which is required for safety. Choose a setup location which will allow for a clearance envelope of at least 30" x 30", (with the centrifuge at the center). No person or hazardous material shall be permitted in the clearance envelope during operation. The operator time within the envelope shall be limited to the time necessary for loading, unloading and centrifuge operation only.
 - c) Proper ventilation is necessary to prevent the overheating of samples as well as premature failure of the centrifuge. Choose an area which will allow unencumbered air flow.
 - d) The centrifuge is designed to rest on its four rubber feet. No adjustment is necessary for leveling the centrifuge, however, the surface should be flat and level.
 - e) Be sure the outlet is always within reach as the line cord is the means of emergency disconnection.

Initial Setup Procedure

If any problems are found during the initial setup procedure, refer to the troubleshooting section. For further assistance, contact Drucker Diagnostics at +1-814-342-6205 or +1-814-692-7661.

1. Plug the female end of the line cord into the rear of the centrifuge. Plug the male end into an approved electrical outlet. For electrical safety, the unit must always be properly grounded.
2. Engage the power button by pressing it in. The power button is engaged when it is illuminated.
3. For operator safety, the locking system is always active; requiring power and direction from the user to disengage it (the lid also automatically unlocks at the end of a run when it is safe to do so). To unlock the lid (in order to access the rotor chamber) press the 'OPEN / STOP' button on the control panel. The 'UNLOCKED' indicator light should illuminate. If it does not, refer to the section on troubleshooting. The lid will remain unlocked for 15 seconds after pressing the 'OPEN / STOP' button.
4. Turn the latch counterclockwise and open the lid.
5. Spin the rotor by hand; check for free and level rotation. If the rotor does not spin freely, refer to the section on troubleshooting.
6. Place the test tube holders (or carriers depending on your rotor type) inside the rotor and verify that they are seated properly.
7. Close the lid. Rotate the lid knob clockwise to its complete stop position. The 'LATCHED' indicator light should be illuminated. If it is not, make sure that the lid is latched properly. The centrifuge will not run unless the lid is latched properly and the 'LATCH' indicator light is illuminated.
8. Use the up arrow button next to the RPM display to set the speed to full. The top speed for the horizontal rotor is 4300RPM. The top speed for the optional fixed-angle rotors is 3200 RPM.
9. Initiate a test run by pressing the 'START' button.

(Continued on next page)



Initial Setup Procedure (continued)

10. The 'RUNNING' indicator light will illuminate.
11. The test tube carriers will slide up into the horizontal position (horizontal rotor only) and the unit will accelerate to the current set speed.
12. Listen to the sound of the centrifuge. A smooth whirring sound should be heard. If there are any loud or unusual sounds, stop the centrifuge by pressing the 'OPEN / STOP' button immediately and refer to the section on troubleshooting.
13. Press the 'OPEN / STOP' button to terminate the test run. The rotor will decelerate to a complete stop and the lid will then unlock automatically for sixty (60) seconds.
14. Take time now to familiarize yourself with the various additional user settings. Turn to page 11.
15. The centrifuge is now ready for operation.

Operation

NOTE: Follow the initial setup procedure before initial operation.

1. Press the 'OPEN / STOP' button to unlock the lid and then open the lid.
2. Insert cushions (if needed) into the tube carriers (holders) for the tube size you are using. Refer to 'Tube Holder Configurations' for assistance.
3. Place the test tube samples into the tube carriers (holders). Be sure to follow the rules for balanced loads.
4. Close the lid and turn the lid knob clockwise to its complete stop position. The 'LATCHED' indicator light should illuminate to indicate that the latch is closed properly. If the lid knob is not completely latched, the 'LATCHED' indicator light will not illuminate and the centrifuge cannot be operated.
5. Set the desired speed and run time using the appropriate up and down arrow buttons.
6. If desired, adjust the braking level, acceleration rate, countdown delay, imbalance sensitivity and audible indication. Turn to page 11 for a description of these features.
7. Begin the run by pressing the 'START' button on the control panel.
8. The centrifuge should begin to spin. The 'RUNNING' indicator light should illuminate.

IF A PROBLEM IS FOUND DURING A SPIN THAT REQUIRES THE CENTRIFUGE TO SHUT DOWN, PRESS THE 'OPEN / STOP' BUTTON IMMEDIATELY !

9. After time has elapsed, the 'RUNNING' indicator light will extinguish and the rotor will decelerate to a complete stop.
10. The 'UNLOCKED' indicator light will illuminate and the locking mechanism will disengage, allowing entry into the rotor chamber. If the automatic unlock times out (after 60 seconds) simply press the 'OPEN / STOP' button.
11. Turn the lid knob counterclockwise and open the lid.
12. Remove the samples.
13. The centrifuge may be used again immediately.



Tube Holder Configurations

The next two pages will describe proper balancing and tube loading. Use the appropriate section for the rotor installed in your centrifuge. Improper loading can result in damage to the centrifuge or test tube samples.

Six (6) Carrier Horizontal Rotor (standard)

This rotor is designed to hold up to 6 tube carriers. There are two carriers available: the 4-position test tube carrier and the 50 mL carrier. Follow the procedure below for proper tube loading.

Your centrifuge must contain a balanced load in order to work properly. To ensure that the load is balanced, keep these rules in mind when inserting test tube samples into the six (6) position horizontal rotor:

1. Opposing tube carriers must be identical.
2. Opposing tube carriers must be empty or loaded with an equal number of equally weighted samples.
3. If an odd number of samples is to be spun, use a water-filled tube to mate with the unpaired one.
4. (Four Position Carriers Only): When loading tubes into opposing carriers, the carriers will be balanced when the tubes are loaded diagonally from one another (not across from one another). For example: six tubes are to be loaded into two carriers. In each carrier, two tubes are placed in the bottom and one tube is placed in the upper left-hand position. See picture at right.

Notes: Do not load more than two (2) tubes per carrier if the tubes are greater than 100 mm long (15 mL). When loading these tubes into the carriers, place them all on either side. For example, to load twelve (12) 15 mL tubes, place two tubes on the right-hand side of each carrier.

Warning: When using glass test tubes, place a 0.25" cushion at the bottom of each location in the carriers. Failure to do so may result in damage to the test tube.

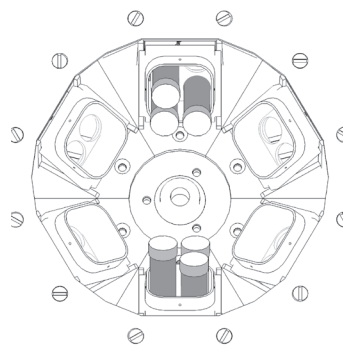
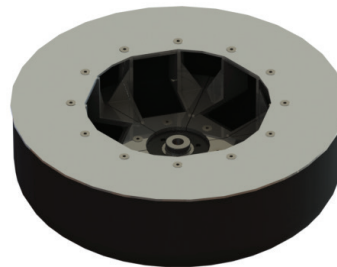

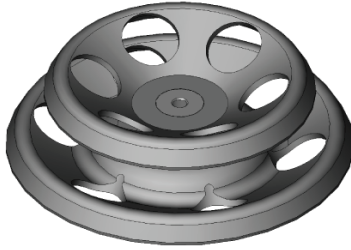

Six (6) Place 50 mL Fixed-angle Rotor (optional)

This rotor is designed to hold up to six (6) 50 mL tube holders.

Your centrifuge must contain a balanced load in order to work properly. To ensure that the load is balanced, keep these rules in mind when inserting test tube samples into the 6 place, 50 mL fixed-angle rotor:

1. Opposing tube holders must be identical.
2. Opposing tube holders must be empty or loaded equally weighted samples.
3. If an odd number of samples is to be spun, use a water-filled tube to mate with the unpaired one.



Control Panel Functions

Time Adjustment and Timer Operation: The run time may be set from 30 seconds to 99 minutes and 30 seconds. Press the up and down arrow buttons next to the time display to adjust the run time. Adjustments may be made prior to a run or after a run begins. A quick tap will adjust the time by 30 seconds. Hold down the button for 1 minute adjustments - continue to hold for 5 minute adjustments.

Press the down button once while 00:30 is displayed to access the “hold” feature. When a “hold” run is initiated, the timer will count up to keep track of total run time. The unit will run for a maximum of 99 minutes and 30 seconds and will then shut off automatically. The “hold” run may also be terminated by pressing the STOP/OPEN button. The total run time during a “hold” run is displayed on the time display until the operator unlocks the lid by pressing the OPEN button or opens the lid (during the automatic unlock after the run ends).

Speed Adjustment / RCF Display: Press the up and down arrow buttons next to the speed display to change to run speed. Adjustments may be made prior to a run or after a run begins. A quick tap will adjust the speed by 50 RPMs. Hold down the button for 100 RPM adjustments. Continue to hold for 500 RPM adjustments.

Press the RCF button at any time to convert the current speed setting to the corresponding force value (xg). The speed may be set by RCF by holding down the RCF button while using the up/down speed set buttons. The jumps made in the RCF value while holding down the RCF button and pressing the up and down arrow buttons correspond to 50 RPM adjustments in speed. Since the RCF is a function of the square of the speed, this jump size will vary.

Starting and Stopping a Run: With the lid switch closed, press the START button to begin a run. Press the STOP/OPEN button at any time during a run to terminate it.

Unlocking the Lid: The lid is unlocked whenever the red UNLOCKED indicator light is illuminated. The lid unlocks automatically for 60 seconds at the end of a run. The lid can also be unlocked for an additional 15 seconds by pressing the OPEN/STOP button while the unit is idle. The lid cannot be unlocked while the rotor is spinning.

Imbalance Detection Reset: This centrifuge is equipped with imbalance detection. If an imbalance is detected, the centrifuge will terminate the current run and will begin to brake to a stop. The words “BALANC” and “ERROR” will flash on the speed display. Once the rotor has stopped, open the lid the cancel the error reporting, balance the load and begin a new run. Alternately, the error reporting can be canceled by pressing the OPEN/STOP button

Advanced User Settings

This centrifuge allow for total control of the run by the user. You may adjust the acceleration rate, adjust the braking rate, adjust the imbalance sensitivity level, select from several audible settings, and use the optional countdown delay.

Acceleration Rate: The user may adjust the acceleration rate from minimum (1) to maximum (10) using the following procedure:

1. While the centrifuge is idle, press the PROGRAM button.
2. Use the UP/DOWN arrow buttons next to the speed display until “ACCEL” is displayed in the speed display.
3. The current acceleration rate is displayed in the time display. Use the ‘UP/ DOWN arrow buttons next to the time display to adjust the acceleration rate from 1 (minimum) to 10 (maximum).
4. Press the PROGRAM button to exit or use the UP/DOWN arrow buttons next to the speed display to adjust additional settings.

Advanced User Settings (continued)

Braking Rate: The user may adjust the braking rate from minimum (slowest deceleration, 0) to maximum (quickest deceleration, 9) using the following procedure:

1. While the centrifuge is idle, press the PROGRAM button.
2. Use the UP/DOWN arrow buttons next to the speed display until “BRAKE” is displayed in the speed display.
3. The current braking rate is displayed in the brake display. Use the UP/DOWN arrow buttons next to the brake display to adjust the braking rate from 0 (minimum) to 9 (maximum).
4. Press the PROGRAM button to exit or use the UP/DOWN arrow buttons next to the speed display to adjust additional settings.

Countdown Delay: When the countdown delay is turned on, the timer will not begin decrementing until the rotor has reached full speed as set by the user. This feature ensures that the samples see full force for the total run time.

1. While the centrifuge is idle, press the PROGRAM button.
2. Use the UP/DOWN arrow buttons next to the speed display until “CNTDLY” is displayed in the speed display.
3. The current status of this feature (ON or OFF) is displayed in the time display. Press UP/DOWN arrows next to the time display to toggle the status between ON and OFF.
4. Press the PROGRAM button to exit or use the UP/DOWN arrow buttons next to the speed display to adjust additional settings.

Audible Settings: The user may select from six different audible indicator levels:

Setting	Button Press	Beep?	End-of-run audible notification
1 NO	NONE
2 YES	NONE
3 NO	YES, 5 beeps
4 YES	YES, 5 beeps
5 NO	YES, continuous, user must press STOP/OPEN button to cancel
6 YES	YES, continuous, user must press STOP/OPEN button to cancel

1. While the centrifuge is idle, press the PROGRAM button.
2. Use the UP/DOWN arrow buttons next to the speed display until “BEEPER” is displayed in the speed display.
3. The current audible selection is displayed in the time display. Use the UP/DOWN arrow buttons next to the time display to select a setting (1 to 6).
4. Press the PROGRAM button to exit or use the UP/DOWN arrow buttons next to the speed display to adjust additional settings.



Memory Locations / Storing and Recalling

The Performance Series centrifuges are capable of storing up to 10 user-defined presets. These memory presets contain all of the settings needed to define a specific run, (run time, speed, acceleration rate, braking rate, etc.). The user can use these memory locations to quickly configure the centrifuge for a specific test type and ensure that the test is run in the same way each time by recalling this same setting.

Store a configuration in a memory location

1. Adjust the various settings (speed, time, acceleration rate, etc.) for the configuration to be saved.
2. Press and hold the PROGRAM button until the preset display begins to flash.
3. Press the MEMORY button to increment the memory location by one. Continue to press the memory button until the desired location is displayed.
4. Press the program button to store the current configuration into the memory location that is displayed.

Recall a configuration from a memory location

1. Press the MEMORY button until the desired memory location is displayed in the memory display.
2. As you review the presets, the settings on the control panel will change to reflect the settings stored in the memory preset currently displayed.
3. When the desired preset is found, pause and the memory display will momentarily flash. The stored configuration is now loaded.

Notes: Once a configuration has been loaded, it will remain active until any change is made on the control panel. If for instance the user adjusts the time, the current configuration will no longer match the previously loaded configuration and the memory display will change to a “-” dash. The previous configuration may be recalled using the procedure described above.

Memory locations may be overwritten by selecting them during the store procedure.

Cycle Counter

This centrifuge is equipped with a mechanical cycle counter to monitor machine usage and for routine maintenance. The cycle counter is located on the front of the centrifuge.





Care and Preventative Maintenance

With proper care and maintenance your Horizon centrifuge will provide years of laboratory service. For proper care, the following steps should be taken:

1. Provide Adequate Ventilation: For cooling purposes, the Horizon draws in ambient air through the air intake cover on the top of the lid and exhausts this air in the rear of the base. The centrifuge should be placed on a hard smooth surface for good air circulation.

2. Always Spin Balanced Loads: This centrifuge is equipped with imbalance detection. However, it is still possible to run loads that are minimally imbalanced, particularly at an imbalance setting of LOW SENSITIVITY. For maximum centrifuge life, set the imbalance detection to HI SENSITIVITY and always run balanced loads. Refer to pages 8 and 9 on for additional information on balancing the load.

3. Keep the Tube Carriers / Holders Clean: NOTE: Always follow the safety guidelines of your laboratory to properly clean up and/or dispose of materials in the event that a substance known to be potentially toxic, radioactive or contaminated with a pathogenic microorganism is spilt in or on the centrifuge. Small glass fragments left in the tube carrier / holder after a tube breakage may adhere to the next test tube inserted in that carrier / holder. When this tube is handled, these fragments may puncture protective gloves and lacerate the operator's fingers or hand. Remaining fragments may provide stress points on subsequent tubes and result in additional breakage. If a tube breakage occurs, carefully remove the tube holder. Properly dispose of the sample and tube fragments and thoroughly clean both the inside and outside of the tube carrier / holder. Insert a new tube cushion (if necessary) and replace the tube carrier / holder in the rotor.

4. Motor and Electrical Maintenance: This centrifuge uses a brushless-DC motor. There are no brushes to replace and it should not need routine servicing for the life of the centrifuge. The electrical components are selected for high reliability and should not need service.

5. Keep the Centrifuge Clean: The cabinet, rotor top and accessories shall be thoroughly cleaned using either isopropyl alcohol, soap and water, or a mild bleach solution. The use of Fully/Partially Halogenated Hydrocarbons, Ketones, Esters and all other chemicals not prescribed by the manufacturer may cause damage to the rotor and tube carriers / holders and shall not be used.

If it is necessary to remove the rotor for additional cleaning it is required that a qualified technician remove the outside housing and rotor assembly. Contact Drucker Diagnostics for additional information.

Apply cleaning solutions with a towel or cloth. Do not submerge the centrifuge in water or other cleaning solutions as this will cause damage and void your warranty!

6. Tube Carrier / Holder Replacement: It is recommended that the tube holders be replaced after 24 months of use. Inspect tube holders regularly for cracks. If cracks are discovered, replace immediately.



Troubleshooting:

▶ 1. Problem: The rotor does not spin freely.

Solutions:

- Make sure that nothing has fallen into the rotor chamber.
- If there is nothing obstructing the rotor, the motor may be damaged.

Contact your authorized dealer or Drucker Diagnostics for further assistance.

▶ 2. Problem: There is excessive noise when the machine is running.

Solutions:

- Check to see that the load is balanced.
- Make sure that nothing has fallen into the rotor chamber.
- Make sure that the screw in the center of the rotor is snug.
- The motor may be damaged.

Contact your authorized dealer or Drucker Diagnostics for further assistance.

▶ 3. Problem: The centrifuge does not run or an error message is displayed.

Solutions:

- Make sure that the centrifuge is getting power. Does the control panel come on? Check the electrical outlet that the unit is plugged into. Check the circuit breaker on the base near the rear of the centrifuge.
- If the unit is getting power, make sure that the lid latch is closed properly. The latch is closed properly when the yellow 'LATCHED' indicator light is illuminated.
- If the centrifuge stops soon after start-up and 'ERROR' is displayed on the speed display, refer to the following for fault information:

ERROR / SPEED

The centrifuge cannot reach full speed due to a problem with the rotor, an inadequate power supply, or other electrical problems. Press the OPEN/ STOP button to cancel the error and then check the rotor and the line voltage. Contact your authorized dealer or Drucker Diagnostics for further assistance.

ERROR / BALANCE

The centrifuge has detected an imbalance. Press the OPEN/STOP button to cancel the error and balance the load. If the load is balanced, make sure that the centrifuge is installed on a secure, level location.

▶ 4. Problem: The lid knob cannot be turned / the lid cannot be unlocked.

Solutions:

- Make sure the centrifuge has power and that the rotor is stopped. Press the 'OPEN/STOP' button. The red 'UNLOCKED' indicator light should illuminate and the unlocked mechanism should disengage, allowing entry into the lid.
- If the lid is still locked, make sure that the red 'UNLOCKED' indicator is illuminated and turn the lid knob first completely clockwise and then counterclockwise.
- If the red 'UNLOCKED' indicator will not illuminate or the locking mechanism will not disengage, the electronics or locking mechanism may be damaged. Have a technician service the centrifuge or contact Drucker Diagnostics for further assistance.

For additional assistance, contact technical support
Monday-Friday, 8:30 AM - 5:00 PM, EST

The Horizon model 755 complies with all requirements of UL's Electrical Equipment for Measurement, Control, and Laboratory Use; Part 1: General Requirements, UL 61010-1, Issued: 7/12/2004, Ed: 2nd, Rev: 10/28/08; Requirements for Electrical Equipment for Measurement, Control, and Laboratory Use Part 1: General Requirements, CSA/C22.2 #61010-1, Issued: 7/12/2004, Ed: 2nd

Safety:

Horizon Lid Safety Switch: The Horizon lid is secured to the top of the cabinet by a latching knob and pawl system. When the knob is rotated clockwise, the pawl grips the underside of the cabinet opening and prevents the lid from opening. A mechanical stop positions the pawl and prevents it from rotating completely. When rotated to the stop position, the pawl makes contact with a micro-switch mounted underneath the cabinet top. The lid safety switch prevents the centrifuge from operating while the lid is open. The yellow 'LATCHED' indicator light on the front of the machine will illuminate when the lid has been latched properly.

Horizon Lid Safety Interlock System: In addition to the Lid Safety Switch, the Horizon has a true "0 RPM" lid locking system. The lid safety interlock system keeps the lid locked at all times, (even during power failure), and requires that the rotor be at rest in order to unlock the lid. The centrifuge will not allow entry into the rotor chamber unless the centrifuge has power and the rotor is stopped. To open the lid, make sure that the centrifuge is plugged in and, with the rotor stopped, press the 'OPEN / EMERGENCY STOP' button.

NOTE: After the centrifuge has started spinning, it may be possible to rotate the lid knob enough to cause the pawl to lose contact with the lid safety switch. If this happens, the centrifuge motor may lose power, but the lid will still remain locked. If the knob is accidentally moved and this situation should occur, rotate the knob fully clockwise to its stop position and the centrifuge will resume operation.

Circuit Breaker: The Horizon is protected with a 4 Amp circuit breaker located at the rear of the machine mounted to the base. Any electrical short circuit will cause the breaker to cut power to the machine.

Emergency Rotor Chamber Entry:



In the event of power failure, it may be impossible to unlock the lid by conventional means. In this case, entry into the rotor chamber may be made by removing the latch label and using a pen to manually disengage the locking mechanism (see photo). Pull the mechanism towards the control panel and then unlatch and open the lid. If the unit is damaged, contact your authorized dealer or Drucker Diagnostics.



Calibration and Earth Ground Testing:

It is recommended that the top speed, ground continuity and line leakage be tested every two years for continued safe operation. Contact Drucker Diagnostics for further information or testing availability.

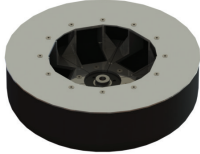
Replacement Parts:

Part No.	Description		
7728052	Foot, rubber		6-Carrier Horizontal Rotor p/n 7786015
7751068	Lid Tray Micro-Switch		
7723002	Lid Tray Solenoid		
7735016	Motor, 1/2 H.P. Brushless DC		Microplate Rotor p/n 7786051
7717041	PC Control Board		
3056001	Step Down Transformer		
7751043	Circuit Breaker		6-Place 50 mL Fixed-Angle Rotor p/n 7786044
7724149	Front Panel Label		
7760003	Line cord		
7714101	Pawl, latch, lid		
7714103	Knob, latch, lid		
7712263	Lid		
7724071	Hinge, friction		
7732018	Gasket, cabinet opening		
7732019	Gasket, rotor chamber		



4-Place Carrier
p/n 7713023



0.25" Tube
Cushion p/n
9150



13 x 100 mm Insert
p/n 7713066



50 mL Carrier
p/n 7713037



50 mL Tube Holder
fixed-angle p/n
7787051



13 x 75 mm Insert
p/n 7713064



Carrier Cap
p/n 7713035



.5 to 1 mL
Tube Adapter
p/n 7713068



1.5 to 2 mL
Tube Adapter
p/n 7713065

**Contact your authorized dealer or Drucker Diagnostics
to order replacement parts or accessories.**

INSTRUCTIONS FOR DISPOSAL OF WEEE BY USERS IN THE EUROPEAN UNION

This product must not be disposed of with other waste. Instead, it is the user's responsibility to dispose of their waste equipment by handing it over to a designated collection point for the recycling of waste electrical and electronic equipment. The separate collection and recycling of your waste equipment at the time of disposal will help to conserve natural resources and ensure that it is recycled in a manner that protects human health and the environment. For more information about where you can drop off your waste equipment for recycling, please contact your local city office, your household waste disposal service, or where you purchased the product.

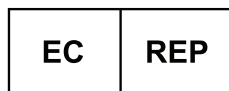

EMERGO EUROPE
Prinsessegracht 20
2514 AP The Hague
The Netherlands

ISO13485
certified

